

# MJD18002D2

## Bipolar NPN Transistor High Speed, High Gain Bipolar NPN Power Transistor with Integrated Collector–Emitter Diode and Built–In Efficient Antisaturation Network

The MJD18002D2 is a state-of-the-art high speed, high gain bipolar transistor (H2BIP). Tight dynamic characteristics and lot to lot minimum spread ( $\pm 150$  ns on storage time) make it ideally suitable for light ballast applications. Therefore, there is no longer a need to guarantee an  $h_{FE}$  window.

### Features

- Low Base Drive Requirement
- High Peak DC Current Gain (55 Typical) @  $I_C = 100$  mA
- **Extremely Low Storage Time Min/Max Guarantees Due to the H2BIP Structure which Minimizes the Spread**
- Integrated Collector–Emitter Free Wheeling Diode
- Fully Characterized and Guaranteed Dynamic  $V_{CEsat}$
- Characteristics Make It Suitable for PFC Application
- Epoxy Meets UL 94 V–0 @ 0.125 in
- ESD Ratings: Human Body Model, 3B > 8000 V  
Machine Model, C > 400 V
- Six Sigma® Process Providing Tight and Reproducible Parameter Spreads
- Pb–Free Package is Available

### MAXIMUM RATINGS

Rating	Symbol	Value	Unit
Collector–Emitter Sustaining Voltage	$V_{CEO}$	450	Vdc
Collector–Base Breakdown Voltage	$V_{CBO}$	1000	Vdc
Collector–Emitter Breakdown Voltage	$V_{CES}$	1000	Vdc
Emitter–Base Voltage	$V_{EBO}$	11	Vdc
Collector Current – Continuous	$I_C$	2.0	Adc
– Peak (Note 1)	$I_{CM}$	5.0	
Base Current – Continuous	$I_B$	1.0	Adc
– Peak (Note 1)	$I_{BM}$	2.0	

### THERMAL CHARACTERISTICS

Characteristic	Symbol	Value	Unit
Total Device Dissipation @ $T_C = 25^\circ\text{C}$ Derate above $25^\circ\text{C}$	$P_D$	50 0.4	W W/ $^\circ\text{C}$
Operating and Storage Temperature Range	$T_J, T_{stg}$	–65 to +150	$^\circ\text{C}$
Thermal Resistance, Junction–to–Case	$R_{\theta JC}$	5.0	$^\circ\text{C}/\text{W}$
Thermal Resistance, Junction–to–Ambient	$R_{\theta JA}$	71.4	$^\circ\text{C}/\text{W}$
Maximum Lead Temperature for Soldering Purposes: 1/8" from Case for 5 seconds	$T_L$	260	$^\circ\text{C}$

Maximum ratings are those values beyond which device damage can occur. Maximum ratings applied to the device are individual stress limit values (not normal operating conditions) and are not valid simultaneously. If these limits are exceeded, device functional operation is not implied, damage may occur and reliability may be affected.

1. Pulse Test: Pulse Width = 5.0 ms, Duty Cycle = 10%.



**ON Semiconductor®**

<http://onsemi.com>

**POWER TRANSISTOR  
2 AMPERES  
1000 VOLTS, 50 WATTS**

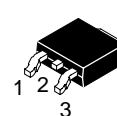
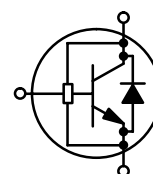

**DPAK  
CASE 369C  
STYLE 1**

### MARKING DIAGRAM

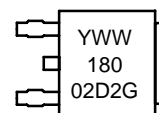

Y = Year  
WW = Work Week  
18002D2 = Device Code  
G = Pb–Free Package

### ORDERING INFORMATION

Device	Package	Shipping†
MJD18002D2T4	DPAK	3000/Tape & Reel
MJD18002D2T4G	DPAK (Pb–Free)	3000/Tape & Reel

†For information on tape and reel specifications, including part orientation and tape sizes, please refer to our Tape and Reel Packaging Specifications Brochure, BRD8011/D.

# MJD18002D2

## ELECTRICAL CHARACTERISTICS (T<sub>C</sub> = 25°C unless otherwise noted)

Characteristic	Symbol	Min	Typ	Max	Unit			
<b>OFF CHARACTERISTICS</b>								
Collector–Emitter Sustaining Voltage (I <sub>C</sub> = 100 mA, L = 25 mH)	V <sub>CEO(sus)</sub>	450	570	–	Vdc			
Collector–Base Breakdown Voltage (I <sub>CBO</sub> = 1 mA)	V <sub>CB0</sub>	1000	1100	–	Vdc			
Emitter–Base Breakdown Voltage (I <sub>EBO</sub> = 1 mA)	V <sub>EBO</sub>	11	14	–	Vdc			
Collector Cutoff Current (V <sub>CE</sub> = Rated V <sub>CEO</sub> , I <sub>B</sub> = 0)	I <sub>CEO</sub>	–	–	100	μAdc			
Collector Cutoff Current (V <sub>CE</sub> = Rated V <sub>CES</sub> , V <sub>EB</sub> = 0)	I <sub>CES</sub>	@ T <sub>C</sub> = 25°C	–	–	100			
(V <sub>CE</sub> = 500 V, V <sub>EB</sub> = 0)		@ T <sub>C</sub> = 125°C	–	–	500			
		@ T <sub>C</sub> = 125°C	–	–	100			
Emitter–Cutoff Current (V <sub>EB</sub> = 10 Vdc, I <sub>C</sub> = 0)	I <sub>EBO</sub>	–	–	500	μAdc			
<b>ON CHARACTERISTICS</b>								
Base–Emitter Saturation Voltage (I <sub>C</sub> = 0.4 Adc, I <sub>B</sub> = 40 mAdc) (I <sub>C</sub> = 1.0 Adc, I <sub>B</sub> = 0.2 Adc)	@ T <sub>C</sub> = 25°C @ T <sub>C</sub> = 25°C	V <sub>BE(sat)</sub>	– –	0.78 0.87	1.0 1.1	Vdc		
Collector–Emitter Saturation Voltage (I <sub>C</sub> = 0.4 Adc, I <sub>B</sub> = 40 mAdc)	@ T <sub>C</sub> = 25°C @ T <sub>C</sub> = 125°C	V <sub>CE(sat)</sub>	– –	0.36 0.50	0.6 1.0	Vdc		
(I <sub>C</sub> = 1.0 Adc, I <sub>B</sub> = 0.2 Adc)	@ T <sub>C</sub> = 25°C @ T <sub>C</sub> = 125°C		– –	0.40 0.65	0.75 1.2			
DC Current Gain (I <sub>C</sub> = 0.4 Adc, V <sub>CE</sub> = 1.0 Vdc)	@ T <sub>C</sub> = 25°C @ T <sub>C</sub> = 125°C	h <sub>FE</sub>	14 8.0	25 15	– –	–		
(I <sub>C</sub> = 1.0 Adc, V <sub>CE</sub> = 1.0 Vdc)	@ T <sub>C</sub> = 25°C @ T <sub>C</sub> = 125°C		6.0 4.0	10 6.0	– –			
<b>DYNAMIC CHARACTERISTICS</b>								
Current Gain Bandwidth (I <sub>C</sub> = 0.5 Adc, V <sub>CE</sub> = 10 Vdc, f = 1 MHz)	f <sub>t</sub>	–	13	–	MHz			
Output Capacitance (V <sub>CB</sub> = 10 Vdc, I <sub>E</sub> = 0, f = 1 MHz)	C <sub>ob</sub>	–	50	100	pF			
Input Capacitance (V <sub>EB</sub> = 8 Vdc)	C <sub>ib</sub>	–	340	500	pF			
<b>DIODE CHARACTERISTICS</b>								
Forward Diode Voltage (I <sub>EC</sub> = 1.0 Adc)	@ T <sub>C</sub> = 25°C	V <sub>EC</sub>	–	1.2	1.5	Vdc		
(I <sub>EC</sub> = 0.4 Adc)	@ T <sub>C</sub> = 25°C		–	1.0	1.3			
	@ T <sub>C</sub> = 125°C		–	0.6	–			
Forward Recovery Time (I <sub>F</sub> = 0.4 Adc, di/dt = 10 A/μs)	@ T <sub>C</sub> = 25°C	t <sub>fr</sub>	–	517	–	ns		
(I <sub>F</sub> = 1.0 Adc, di/dt = 10 A/μs)	@ T <sub>C</sub> = 25°C		–	480	–			
<b>DYNAMIC SATURATION VOLTAGE</b>								
Dynamic Saturation Voltage Determined 1 μs and 3 μs respectively after rising I <sub>B1</sub> reaches 90% of final I <sub>B1</sub>	I <sub>C</sub> = 0.4 Adc I <sub>B1</sub> = 40 mA V <sub>CC</sub> = 300 Vdc	@ 1 μs	@ T <sub>C</sub> = 25°C	V <sub>CE(dsat)</sub>	–	7.4	–	V
		@ 3 μs	@ T <sub>C</sub> = 25°C		–	2.5	–	
	I <sub>C</sub> = 1 Adc I <sub>B1</sub> = 0.2 A V <sub>CC</sub> = 300 Vdc	@ 1 μs	@ T <sub>C</sub> = 25°C		–	11.7	–	
		@ 3 μs	@ T <sub>C</sub> = 25°C		–	1.3	–	

# MJD18002D2

## ELECTRICAL CHARACTERISTICS ( $T_C = 25^\circ\text{C}$ unless otherwise noted)

Characteristic	Symbol	Min	Typ	Max	Unit			
<b>SWITCHING CHARACTERISTICS: Resistive Load</b> (D.C.S. 10%, Pulse Width = 40 $\mu\text{s}$ )								
Turn-on Time	$I_C = 0.4 \text{ Adc}$ , $I_{B1} = 40 \text{ mA dc}$ $I_{B2} = 200 \text{ mA dc}$ $V_{CC} = 300 \text{ V dc}$	@ $T_C = 25^\circ\text{C}$	$t_{on}$	–	225	350	ns	
Turn-off Time		@ $T_C = 125^\circ\text{C}$	$t_{off}$	0.8	–	1.1	–	$\mu\text{s}$
Turn-on Time	$I_C = 1.0 \text{ Adc}$ , $I_{B1} = 0.2 \text{ Adc}$ $I_{B2} = 0.5 \text{ Adc}$ $V_{CC} = 300 \text{ V dc}$	@ $T_C = 25^\circ\text{C}$	$t_{on}$	–	100	150	ns	
Turn-off Time		@ $T_C = 125^\circ\text{C}$	$t_{off}$	0.95	–	1.25	–	$\mu\text{s}$
<b>SWITCHING CHARACTERISTICS: Inductive Load</b> ( $V_{clamp} = 300 \text{ V}$ , $V_{CC} = 15 \text{ V}$ , $L = 200 \mu\text{H}$ )								
Fall Time	$I_C = 0.4 \text{ Adc}$ $I_{B1} = 40 \text{ mA dc}$ $I_{B2} = 0.2 \text{ Adc}$	@ $T_C = 25^\circ\text{C}$	$t_f$	–	130	175	ns	
Storage Time		@ $T_C = 125^\circ\text{C}$	$t_s$	0.4	–	0.7	–	$\mu\text{s}$
Cross-over Time		@ $T_C = 25^\circ\text{C}$ @ $T_C = 125^\circ\text{C}$	$t_c$	–	110	175	–	ns
Fall Time	$I_C = 0.8 \text{ Adc}$ $I_{B1} = 160 \text{ mA dc}$ $I_{B2} = 160 \text{ mA dc}$	@ $T_C = 25^\circ\text{C}$	$t_f$	–	130	175	ns	
Storage Time		@ $T_C = 125^\circ\text{C}$	$t_s$	2.1	–	3.0	–	$\mu\text{s}$
Cross-over Time		@ $T_C = 25^\circ\text{C}$ @ $T_C = 125^\circ\text{C}$	$t_c$	–	275	350	–	ns
Fall Time	$I_C = 1.0 \text{ Adc}$ $I_{B1} = 0.2 \text{ Adc}$ $I_{B2} = 0.5 \text{ Adc}$	@ $T_C = 25^\circ\text{C}$	$t_f$	–	100	150	ns	
Storage Time		@ $T_C = 125^\circ\text{C}$	$t_s$	–	1.05	1.2	–	$\mu\text{s}$
Cross-over Time		@ $T_C = 25^\circ\text{C}$ @ $T_C = 125^\circ\text{C}$	$t_c$	–	100	150	–	ns

Typical Static Characteristics

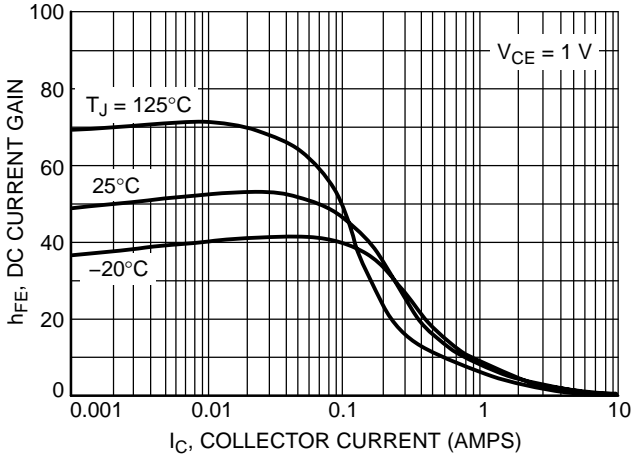

Figure 1. DC Current Gain @ 1 V

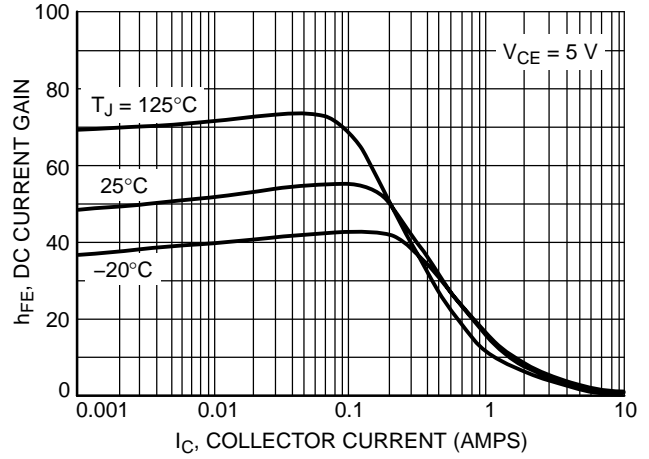

Figure 2. DC Current Gain @ 5 V

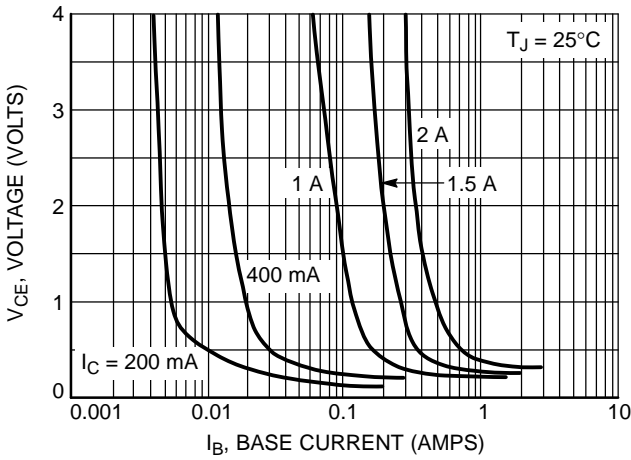

Figure 3. Collector Saturation Region

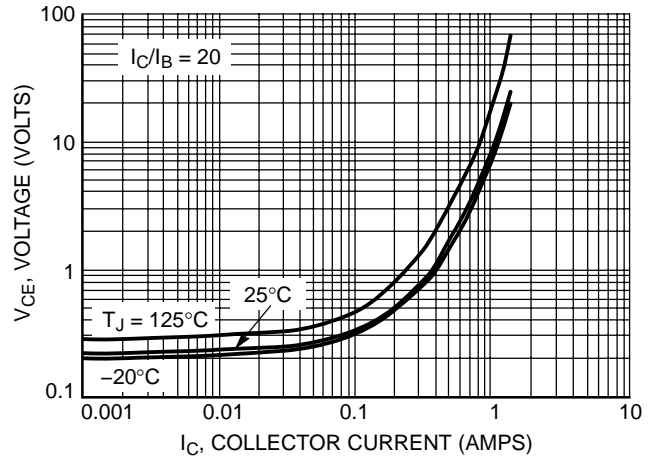

Figure 4. Collector-Emitter Saturation Voltage

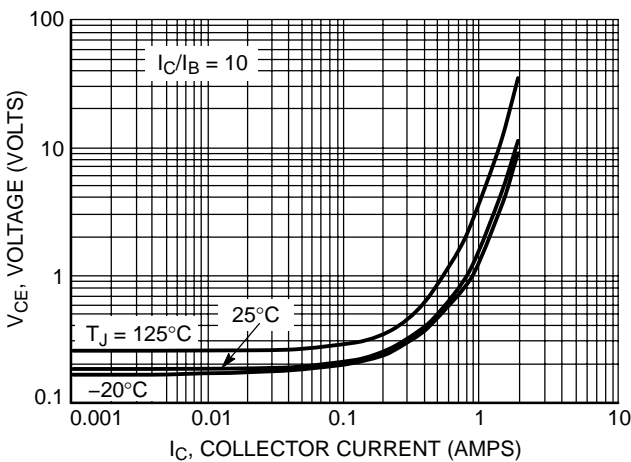

Figure 5. Collector-Emitter Saturation Voltage

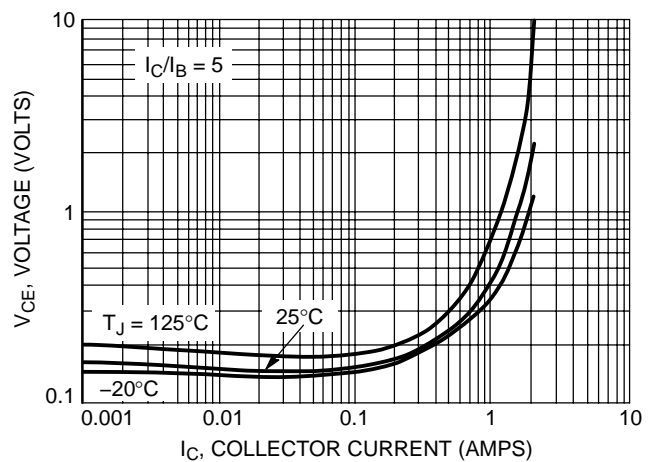

Figure 6. Collector-Emitter Saturation Voltage

Typical Static Characteristics

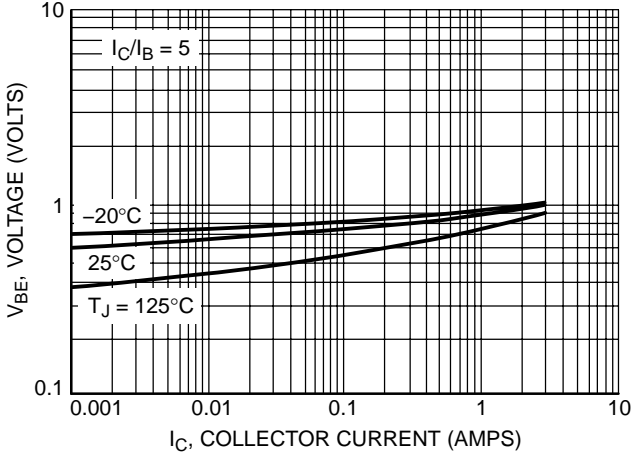

Figure 7. Base-Emitter Saturation Region  
 $I_C/I_B = 5$

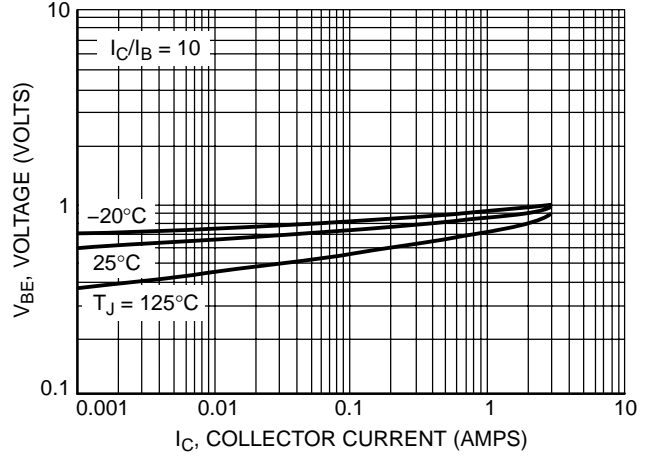

Figure 8. Base-Emitter Saturation Region  
 $I_C/I_B = 10$

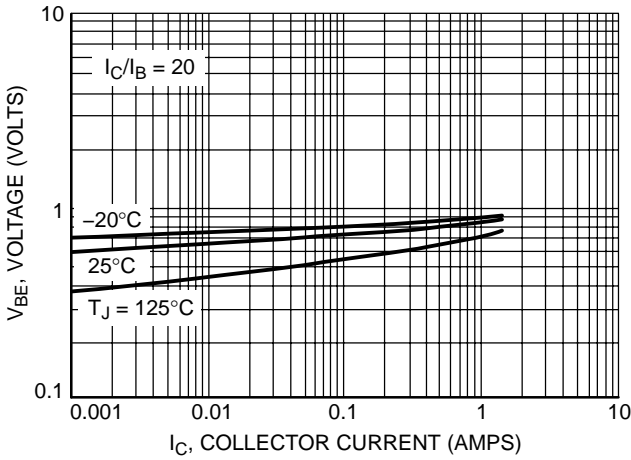

Figure 9. Base-Emitter Saturation Region  
 $I_C/I_B = 20$

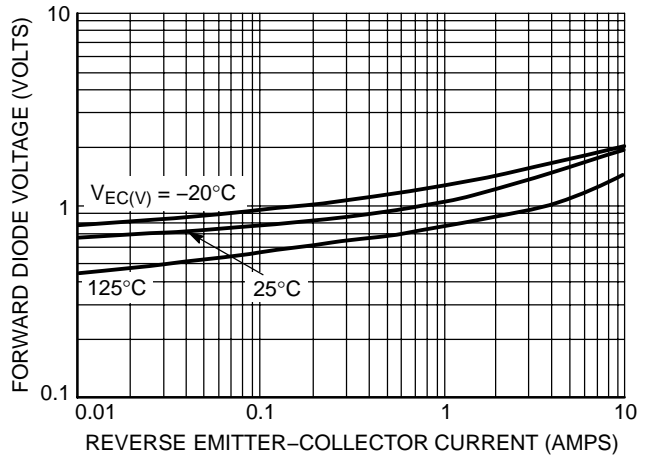

Figure 10. Forward Diode Voltage

Typical Switching Characteristics

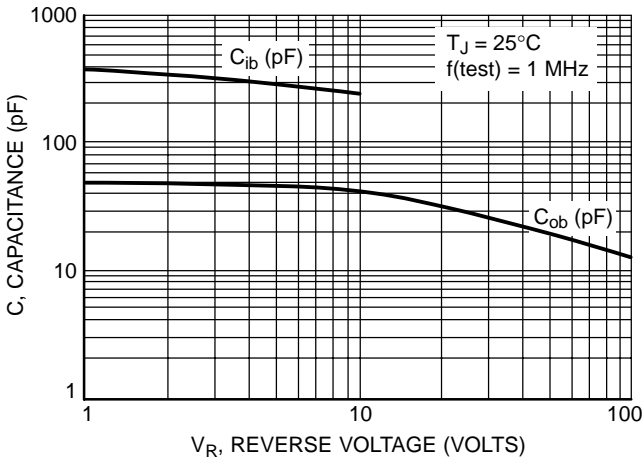

Figure 11. Capacitance

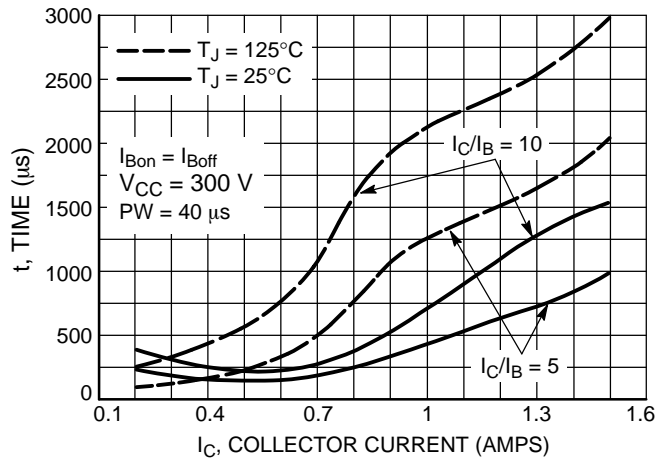

Figure 12. Resistive Switch Time,  $t_{on}$

Typical Switching Characteristics

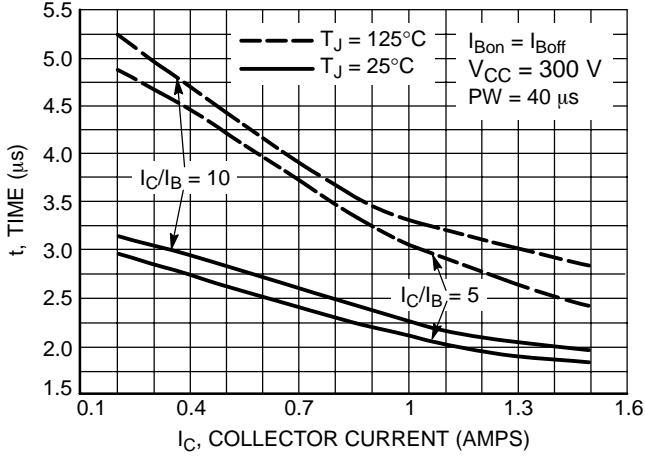

Figure 13. Resistive Switch Time,  $t_{off}$

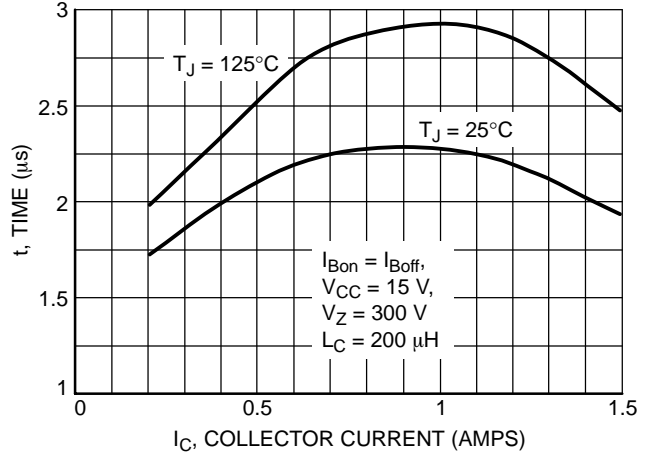

Figure 14. Inductive Storage Time,  $t_{si}$  @  $I_C/I_B = 5$

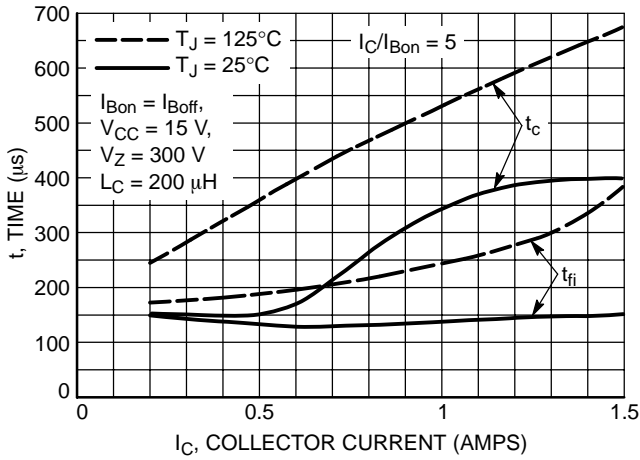

Figure 15. Inductive Switching,  $t_c$  &  $t_{fi}$  @  $I_C/I_B = 5$

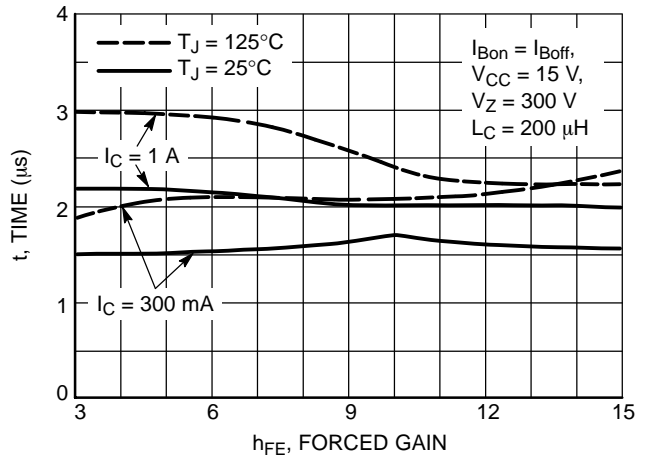

Figure 16. Inductive Storage Time

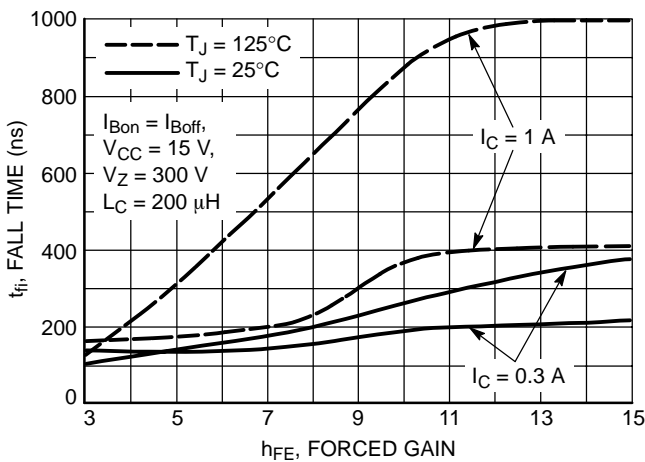

Figure 17. Inductive Fall Time

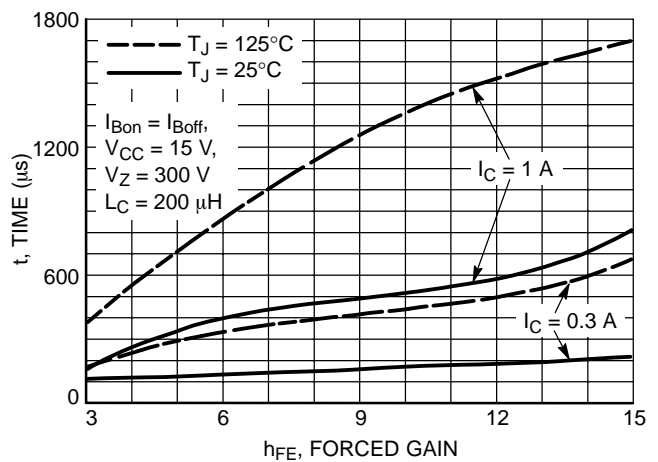

Figure 18. Inductive Cross-Over Time

Typical Switching Characteristics

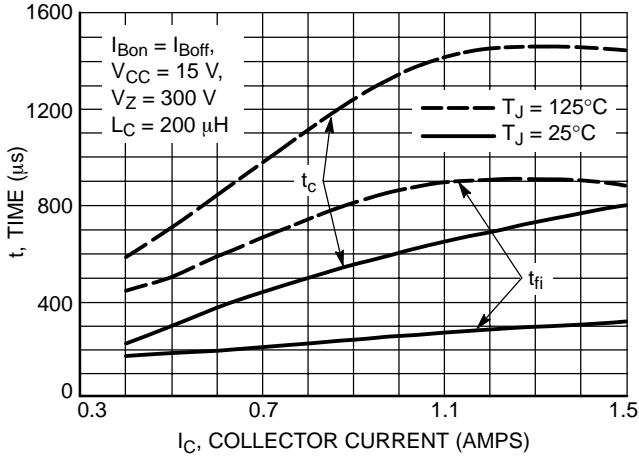

Figure 19. Inductive Switching Time,  $t_{fi}$  &  $T_C$  @  $G = 10$

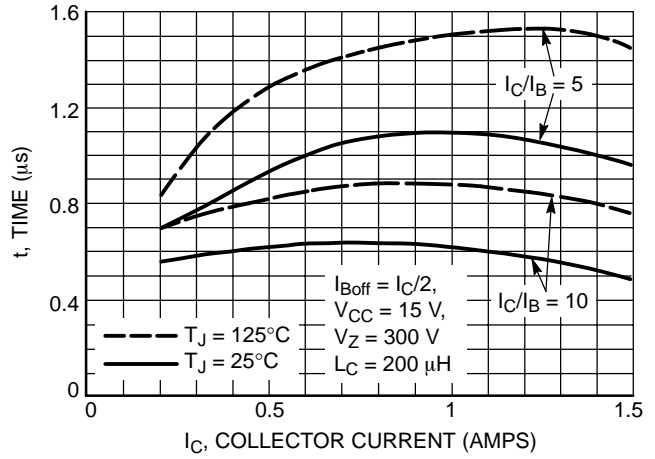

Figure 20. Inductive Switching Time,  $t_{si}$

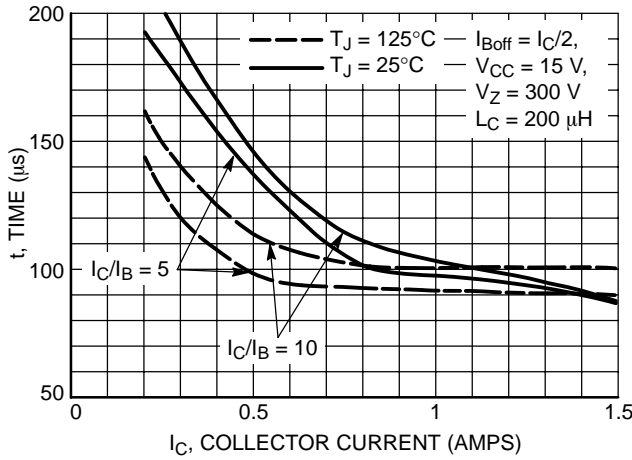

Figure 21. Inductive Storage Time,  $t_{fi}$

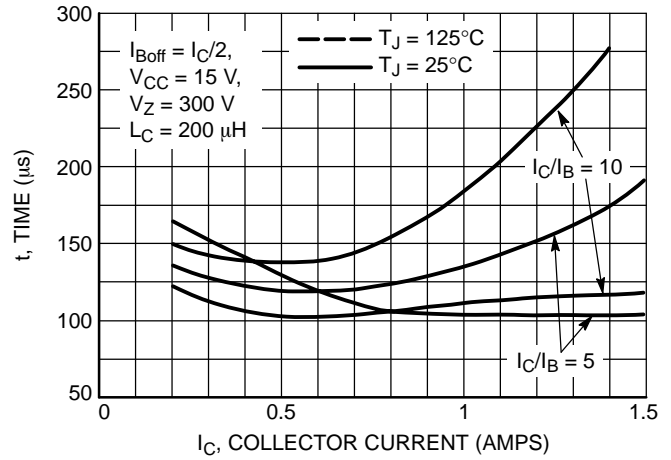

Figure 22. Inductive Storage Time,  $t_c$

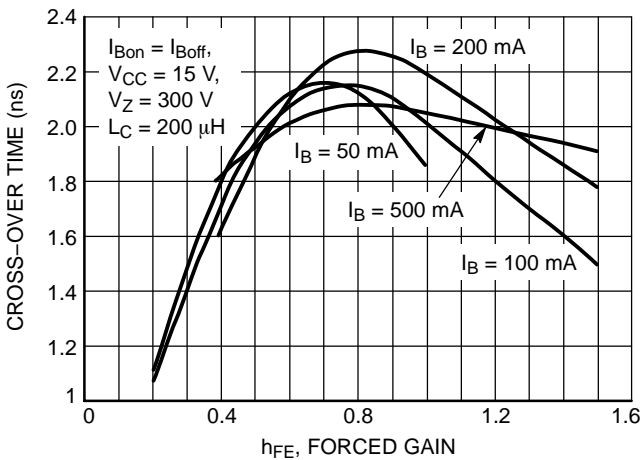

Figure 23. Inductive Storage Time,  $t_{si}$

Figure 24. Dynamic Saturation Voltage Measurements

# MJD18002D2

## Typical Switching Characteristics

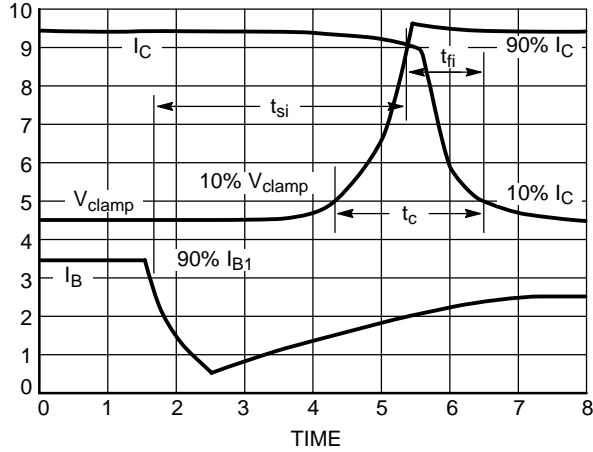
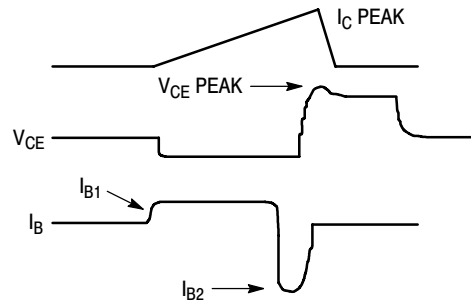
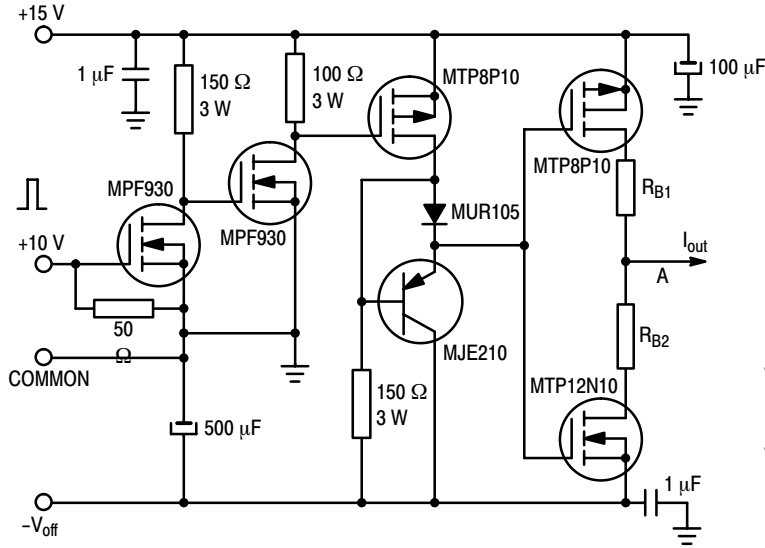

Figure 25. Inductive Switching Measurements

Table 1. Inductive Load Switching Drive Circuit



$V_{(BR)CEO(sus)}$   
 $L = 10 \text{ mH}$   
 $R_{B2} = \infty$   
 $V_{CC} = 20 \text{ Volts}$   
 $I_{C(pk)} = 100 \text{ mA}$

**Inductive Switching**  
 $L = 200 \mu\text{H}$   
 $R_{B2} = 0$   
 $V_{CC} = 15 \text{ Volts}$   
 $R_{B1}$  selected for  
 desired  $I_{B1}$

**RBSOA**  
 $L = 500 \mu\text{H}$   
 $R_{B2} = 0$   
 $V_{CC} = 15 \text{ Volts}$   
 $R_{B1}$  selected for  
 desired  $I_{B1}$



# MJD18002D2

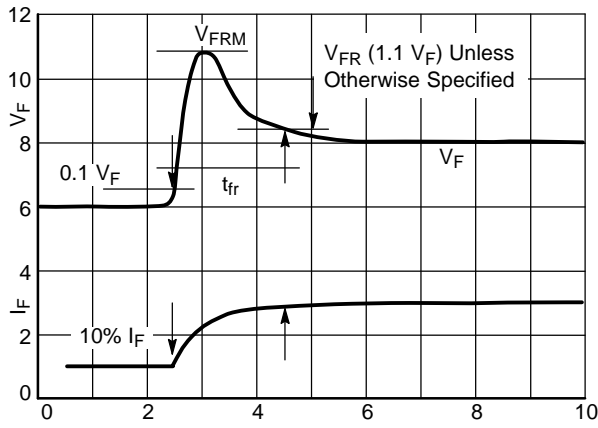

Figure 26.  $t_{fr}$  Measurement

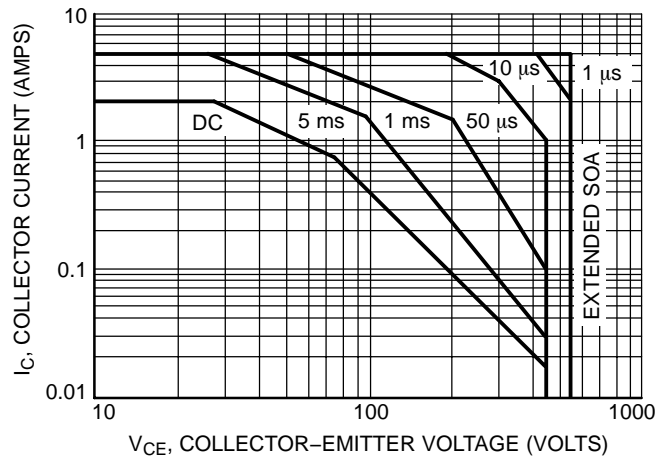

Figure 27. Forward Bias Safe Operating Area

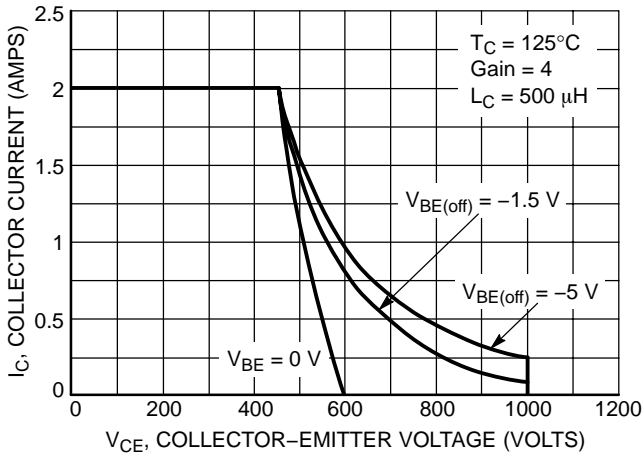

Figure 28. Reverse Bias Safe Operating Area

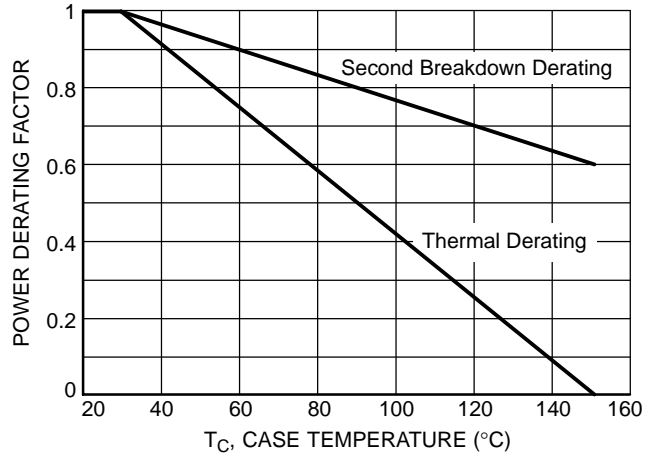

Figure 29. Forward Bias Power Derating

There are two limitations on the power handling ability of a transistor: average junction temperature and second breakdown. Safe operating area curves indicate  $I_C$ - $V_{CE}$  limits of the transistor that must be observed for reliable operation; i.e., the transistor must not be subjected to greater dissipation than the curves indicate. The data of Figure 27 is based on  $T_C = 25^\circ\text{C}$ ;  $T_{J(pk)}$  is variable depending on power level. Second breakdown pulse limits are valid for duty cycles to 10% but must be derated when  $T_C > 25^\circ\text{C}$ . Second Breakdown limitations do not derate the same as thermal limitations. Allowable current at the voltages shown on

Figure 27 may be found at any case temperature by using the appropriate curve on Figure 29.

$T_{J(pk)}$  may be calculated from the data in Figure 30. At any case temperatures, thermal limitations will reduce the power that can be handled to values less than the limitations imposed by second breakdown. For inductive loads, high voltage and current must be sustained simultaneously during turn-off with the base to emitter junction reverse biased. The safe level is specified as a reverse biased safe operating area (Figure 28). This rating is verified under clamped conditions so that the device is never subjected to an avalanche mode.

# MJD18002D2

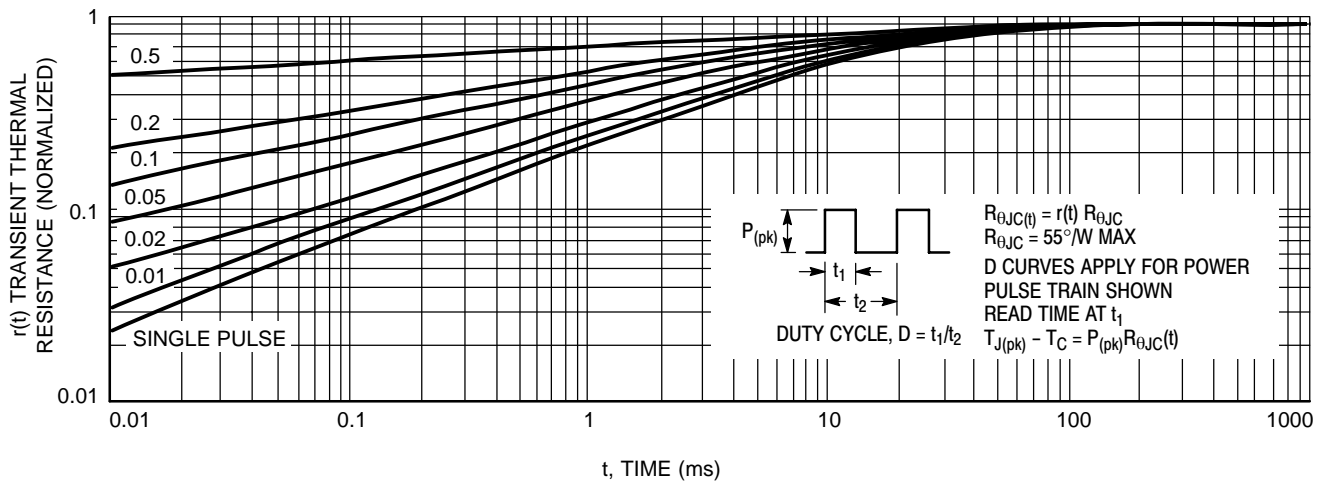

Figure 30. Typical Thermal Response ( $Z_{\theta JC}(t)$ ) for MJD18002D2

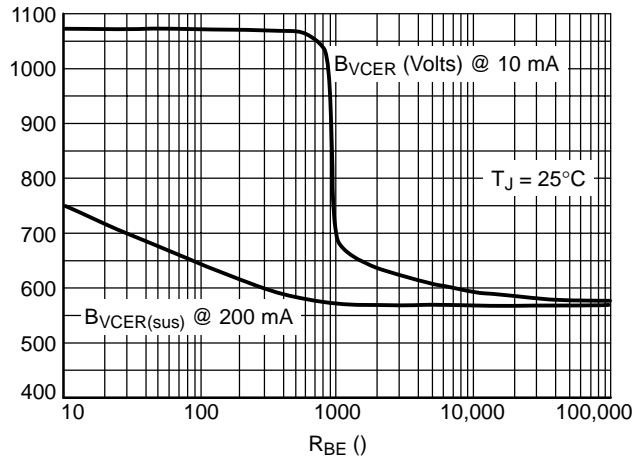

Figure 31.  $B_{VCER}$

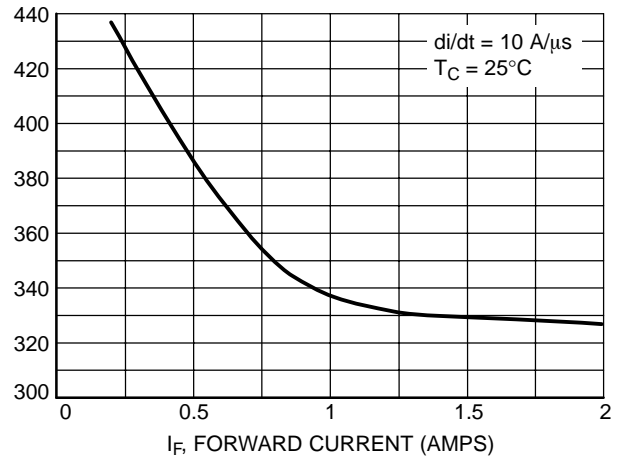
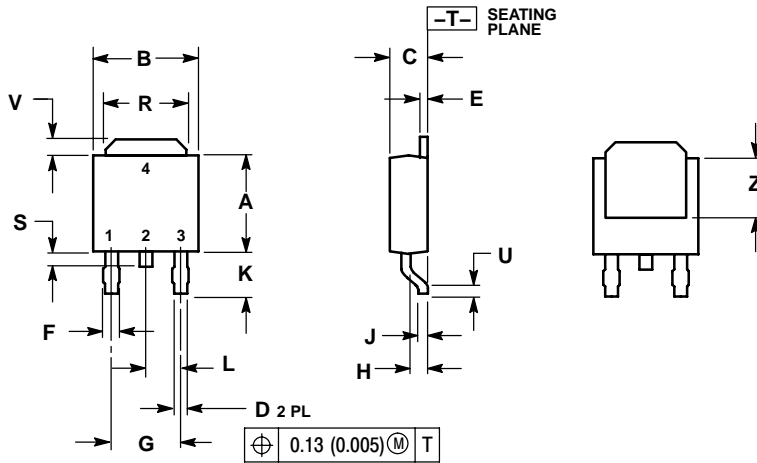

Figure 32. Forward Recovery Time,  $t_{fr}$

# MJD18002D2

## PACKAGE DIMENSIONS

DPAK  
CASE 369C  
ISSUE O



- NOTES:  
1. DIMENSIONING AND TOLERANCING PER ANSI Y14.5M, 1982.  
2. CONTROLLING DIMENSION: INCH.

DIM	INCHES		MILLIMETERS	
	MIN	MAX	MIN	MAX
A	0.235	0.245	5.97	6.22
B	0.250	0.265	6.35	6.73
C	0.086	0.094	2.19	2.38
D	0.027	0.035	0.69	0.88
E	0.018	0.023	0.46	0.58
F	0.037	0.045	0.94	1.14
G	0.180 BSC		4.58 BSC	
H	0.034	0.040	0.87	1.01
J	0.018	0.023	0.46	0.58
K	0.102	0.114	2.60	2.89
L	0.090 BSC		2.29 BSC	
R	0.180	0.215	4.57	5.45
S	0.025	0.040	0.63	1.01
U	0.020	---	0.51	---
V	0.035	0.050	0.89	1.27
Z	0.155	---	3.93	---

- STYLE 1:  
PIN 1. BASE  
2. COLLECTOR  
3. EMITTER  
4. COLLECTOR

### SOLDERING FOOTPRINT\*

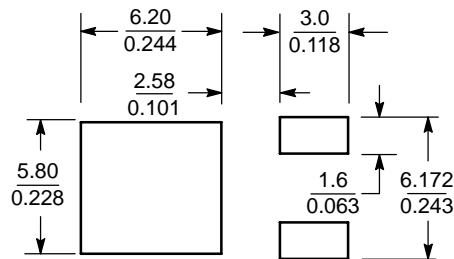

SCALE 3:1 (mm/inches)

\*For additional information on our Pb-Free strategy and soldering details, please download the ON Semiconductor Soldering and Mounting Techniques Reference Manual, SOLDERRM/D.

Six Sigma is a registered trademark and servicemark of Motorola, Inc.

ON Semiconductor and are registered trademarks of Semiconductor Components Industries, LLC (SCILLC). SCILLC reserves the right to make changes without further notice to any products herein. SCILLC makes no warranty, representation or guarantee regarding the suitability of its products for any particular purpose, nor does SCILLC assume any liability arising out of the application or use of any product or circuit, and specifically disclaims any and all liability, including without limitation special, consequential or incidental damages. "Typical" parameters which may be provided in SCILLC data sheets and/or specifications can and do vary in different applications and actual performance may vary over time. All operating parameters, including "Typicals" must be validated for each customer application by customer's technical experts. SCILLC does not convey any license under its patent rights nor the rights of others. SCILLC products are not designed, intended, or authorized for use as components in systems intended for surgical implant into the body, or other applications intended to support or sustain life, or for any other application in which the failure of the SCILLC product could create a situation where personal injury or death may occur. Should Buyer purchase or use SCILLC products for any such unintended or unauthorized application, Buyer shall indemnify and hold SCILLC and its officers, employees, subsidiaries, affiliates, and distributors harmless against all claims, costs, damages, and expenses, and reasonable attorney fees arising out of, directly or indirectly, any claim of personal injury or death associated with such unintended or unauthorized use, even if such claim alleges that SCILLC was negligent regarding the design or manufacture of the part. SCILLC is an Equal Opportunity/Affirmative Action Employer. This literature is subject to all applicable copyright laws and is not for resale in any manner.

### PUBLICATION ORDERING INFORMATION

**LITERATURE FULFILLMENT:**  
Literature Distribution Center for ON Semiconductor  
P.O. Box 61312, Phoenix, Arizona 85082-1312 USA  
**Phone:** 480-829-7710 or 800-344-3860 Toll Free USA/Canada  
**Fax:** 480-829-7709 or 800-344-3867 Toll Free USA/Canada  
**Email:** orderlit@onsemi.com

**N. American Technical Support:** 800-282-9855 Toll Free  
USA/Canada

**Japan:** ON Semiconductor, Japan Customer Focus Center  
2-9-1 Kamimeguro, Meguro-ku, Tokyo, Japan 153-0051  
**Phone:** 81-3-5773-3850

**ON Semiconductor Website:** <http://onsemi.com>

**Order Literature:** <http://www.onsemi.com/litorder>

For additional information, please contact your local Sales Representative.

MJD18002D2/D